

Article number: 20240843770DD

Description: E+G Telescope-Lear motion bearings GN 2408-43-770-DD

## Measures

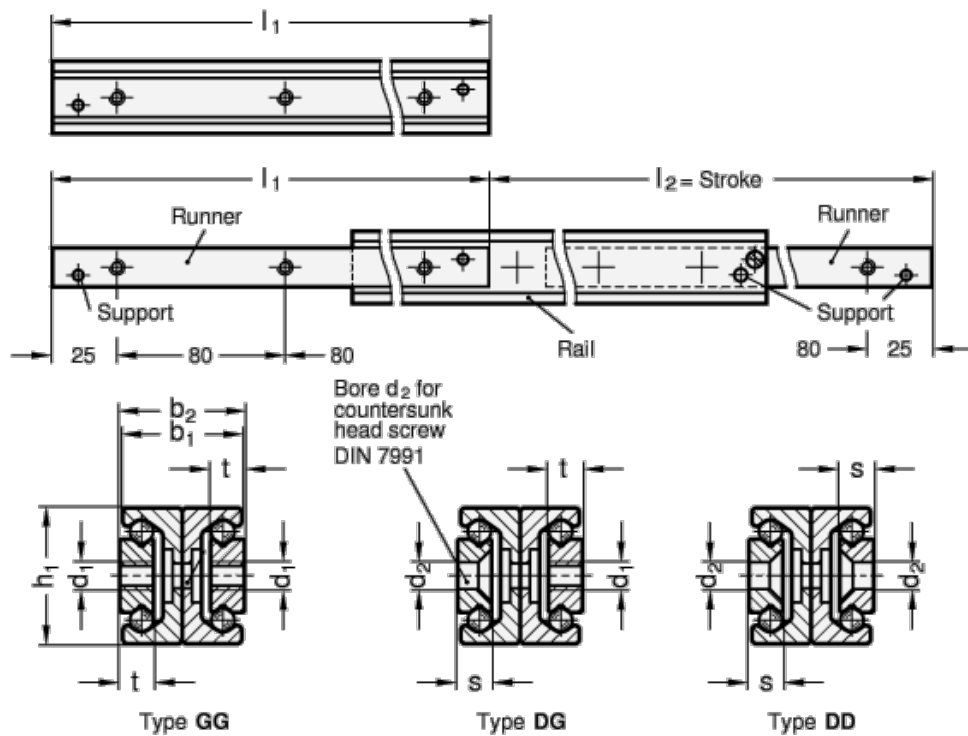

$b_1 = 42$   
 $b_2 = 44$   
 $d_1 =$   
 $d_2 = 8.5$   
 $h_1 = 43$   
 $L_1 = 770 - 796$   
 $s = 4.5$   
 $t =$

Weight in (g) = 8090